



1-800-779-2102

Mon – Thurs: 8:00am - 5:00pm | Friday: 8:00am - 4:00pm CST

**INSPECT YOUR PRODUCT FOR DAMAGE & MISSING
PARTS BEFORE PROCEEDING TO INSTALLATION**

PROCEDURE FOR RETURNS OR MISSING HARDWARE

-PLEASE CONTACT THE ORIGINAL POINT OF PURCHASE FOR:
SHIPPING DAMAGE, RETURNS, OR WARRANTY CLAIMS

-CONTACT DEE ZEE DIRECTLY FOR MISSING PARTS OR HARDWARE

WWW.DEEZEE.COM

REGISTER YOUR PRODUCT ONLINE: www.deezee.com/registration

VIEW INSTRUCTIONS ONLINE: www.deezee.com/instructions

⚠ WARNING: Cancer and Reproductive Harm
www.P65Warnings.ca.gov

Operating, servicing, and maintaining a passenger vehicle can expose you to chemicals such as lead, phthalates, engine exhaust, and carbon monoxide that are known to the State of California cause cancer and birth defects or other reproductive harm. To minimize exposure, service your vehicle and its accessories in a well-vented area and wear gloves or wash your hands frequently.



DEE ZEE, INC. WARRANTY AGREEMENT

Dee Zee, Inc. guarantees the original purchaser a limited lifetime warranty against manufacturer defects in materials, workmanship, and design under normal use, excluding damage resulting from road hazards such as gravel or other debris, product misuse, improper installation, impairments from accidents, product modifications, improper repairs, spills, vandalism, product neglect, or acts of God.

This warranty applies only to the original purchaser of new product(s) and is limited to the replacement of genuine Dee Zee products. Modification of any kind to Dee Zee products voids all warranty coverage. Warranty does not include electrical components, installation, cost of removal, labor, transportation costs, loss of use, inconvenience, or consequential damages.

WARRANTY COVERAGE - MATERIALS & WORKMANSHIP

LIMITED LIFETIME WARRANTY:

- STAINLESS STEEL: Side Steps, Grill Guards, Bull Bars, Bed Caps, and Side Rails
- ALUMINUM: Side Steps, Running Boards, Storage Boxes, Transfer Tanks, Bed Protection, Side Rails, Invis-A-Racks, and Cab Racks
- PLASTIC: Storage Boxes
- OTHER: Front and Rear Bumpers

THREE-YEAR WARRANTY:

- POWDER-COATED / E-COATED STEEL: Side Steps, Running Boards, Storage Boxes, Transfer Tanks, Cab Racks, Sport Bar Ladder Racks, Cargo Carriers, Mounting Brackets (NX, Rough Step, and Bumper Guards only)
- OTHER: Tailgate Assist, Bed Mats, Floor Mats, Auxiliary Fuel Connection Kits, and All Products Not Otherwise Listed Individually

WARRANTY COVERAGE – FINISH PROTECTION

The finish of all Dee Zee products is covered for one-year (1) from the date of purchase. Dee Zee products have a high quality finish that must be cared for and maintained like any other exposed finish on the vehicle. Protect the finish with non-abrasive automotive wax (e.g. Pure Carnauba) on a regular basis. Applying soaps, polishes, or waxes that contain an abrasive compound may scratch the finish and leave the exposed material susceptible to corrosion.

WARRANTY COVERAGE – COMPONENT PARTS

Operational items such as shocks, latches, hinges, and wear items including, but not limited to, mud flaps, step pads, toolbox tray, end caps, hardware, seals, etc. have a one-year (1) warranty. Replacement component parts can be ordered via credit card (MasterCard or VISA) by calling 1-800-779-2102. All replacement parts are non-returnable and non-refundable.

GPI® FUEL PUMPS & ACCESSORIES

All Great Plains Industries (GPI) products, including transfer tank pumps and fuel meters are covered by GPI's warranty policies. Dee Zee's warranty terms do not apply to GPI products. To submit a warranty claim, please contact GPI at 1-800-835-0113 or visit www.gpi.net.

WARRANTY SUBMISSION PROCEDURE

All warranty claims will be initiated at the place of purchase. The original purchaser will be required to present the original sales receipt with purchase date shown and provide photographs of the defect.

In the event the originally purchased product style is no longer available, Dee Zee will warranty the defective part with a current equivalent. If a comparable product is no longer available, the product would be returned to the store of purchase for a refund or the applicable cost difference can be paid to choose an alternate style.

DISCLAIMER

All products are sold as appearance accessories and should not be relied upon as protection for the vehicle or its occupants in the event of an accident. Vehicles equipped with a supplemental restraints system (air bags) deployed by impact and collision avoidance systems should not be modified in any way. Always consult the vehicle manufacturer if you have any questions regarding supplemental restraint systems and sensors.

Buyer must accommodate front and rear sensors during product installation and assumes all risk should these be tampered, rerouted, severed, or disconnected. This includes disabling visual, audio, or vibration alerts into the cab. Buyer assumes all risk and responsibility for wiring any supplemental auxiliary lights.

Buyer assumes all risk, liability, and cost for the installation and use of Dee Zee products. Dee Zee, Inc. assumes no liability for injury, loss, incidental or consequential damages in the event of an accident.



Thank you for choosing Dee Zee to add function and accessorize your vehicle. Dee Zee has been a staple brand in the truck accessory market since 1977 and we hold a reputation of quality manufacturing based in America's Heartland. Our products are born through careful engineering and backed by industry leading warranty programs. We appreciate the opportunity to serve you and your vehicle!

Review the instruction pages in their entirety to prepare the required tools

Warning: Please check for wiring or other obstructions before drilling any holes in the vehicle. If it is necessary to drill any holes, Dee Zee recommends putting a sealant or rust inhibitory around all holes drilled into the body of the vehicle.

It is the sole responsibility of the vehicle owner to check for tire clearance. It is unlawful and dangerous to ride on any external vehicle step while the vehicle is in motion.

Cleaning: To be entitled to all warranty rights offered with the product, Dee Zee steps need to be cleaned regularly with a mild detergent. Do NOT use abrasive cleaners. For stainless steel products, the application of a high grade automotive wax is recommended.



Dee Zee Cares - Please Recycle

For an electronic version of these instructions visit: www.deezee.com/instructions

Register your product online: www.deezee.com/registration

Rear Rough Step Running Board Installation Instructions

DZ 15328R 2013-Current Ford Transit

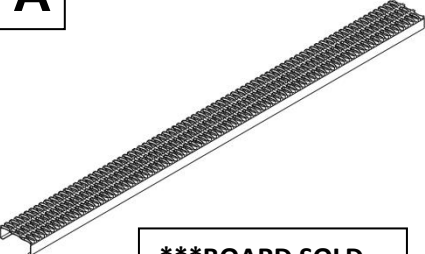
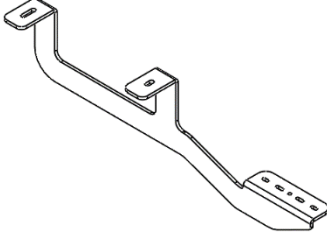
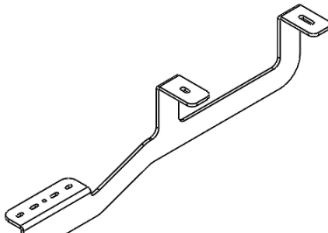
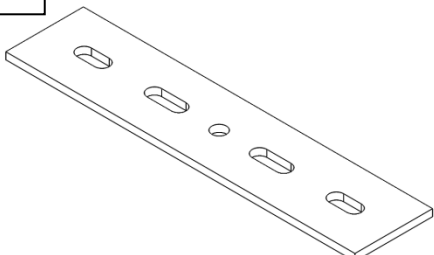
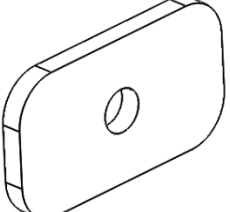
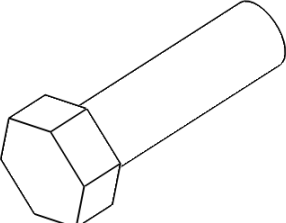
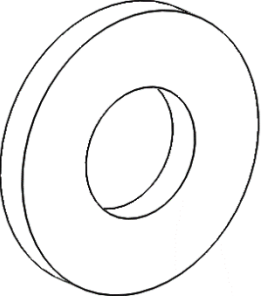
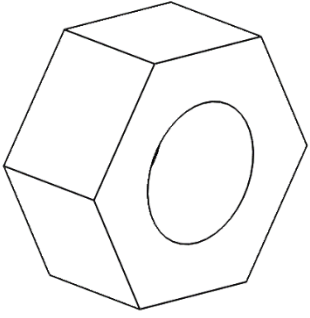
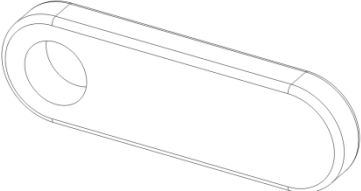
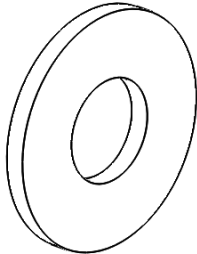
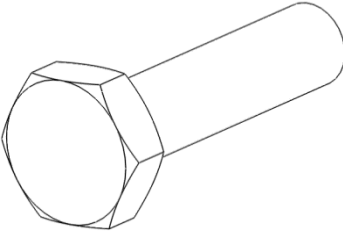
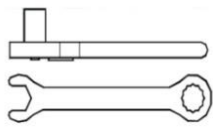
<p>A Running Board</p>  <div style="border: 1px solid black; padding: 2px; width: fit-content; margin: 5px auto;"> <p>***BOARD SOLD SEPERATELY</p> </div> <p>Various X1</p>	<p>B Left Bracket</p>  <p>B 2418LP X1</p>	<p>C Right Bracket</p>  <p>B 2418RP X1</p>
<p>D Strap bracket</p>  <p>B 1791P X2</p>	<p>E Large Thread Plate</p>  <p>PN 407 X2</p>	<p>F 3/8-16 X 1 1/4 CD 5 HHCS Zin-Black</p>  <p>PN 114B X4</p>
<p>G 1/4" Washer</p>  <p>PN 72B X12</p>	<p>H 1/4-20 Hex Nut</p>  <p>PN 71B X6</p>	<p>I M10 Threaded Plate</p>  <p>PN 742 X2</p>
<p>J 3/8 Flat Washer</p>  <p>PN 113B X4</p>	<p>K 1/4-20 Hex Cap Bolt</p>  <p>PN 96B X6</p>	<p style="text-align: center;">Tools Required</p> <p>Ratchet / Wrench 7/16 9/16 15mm</p> 

1

Below are the mounting locations for the rear step brackets on the left side.

Front



Rear



2

Insert the large thread plate (E) into the area shown below in the picture on the left. Then align the hole in the plate with the hole in the frame as shown in the right picture.

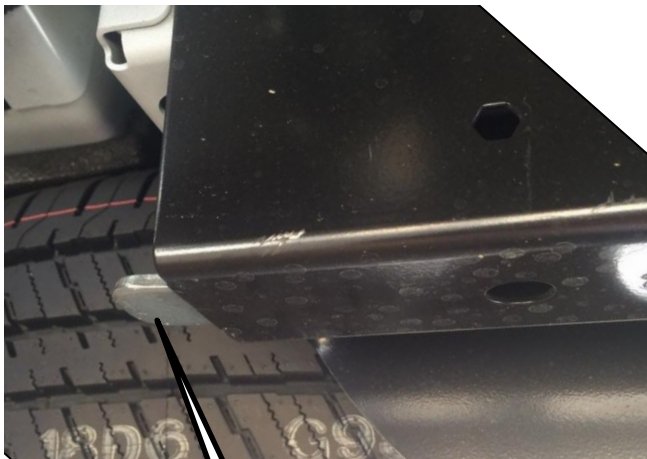

E



- 3** Insert bolt (F) with washer (J) into the left bracket (B) as shown. Then start the M10 thread plate (I) onto the bolt.

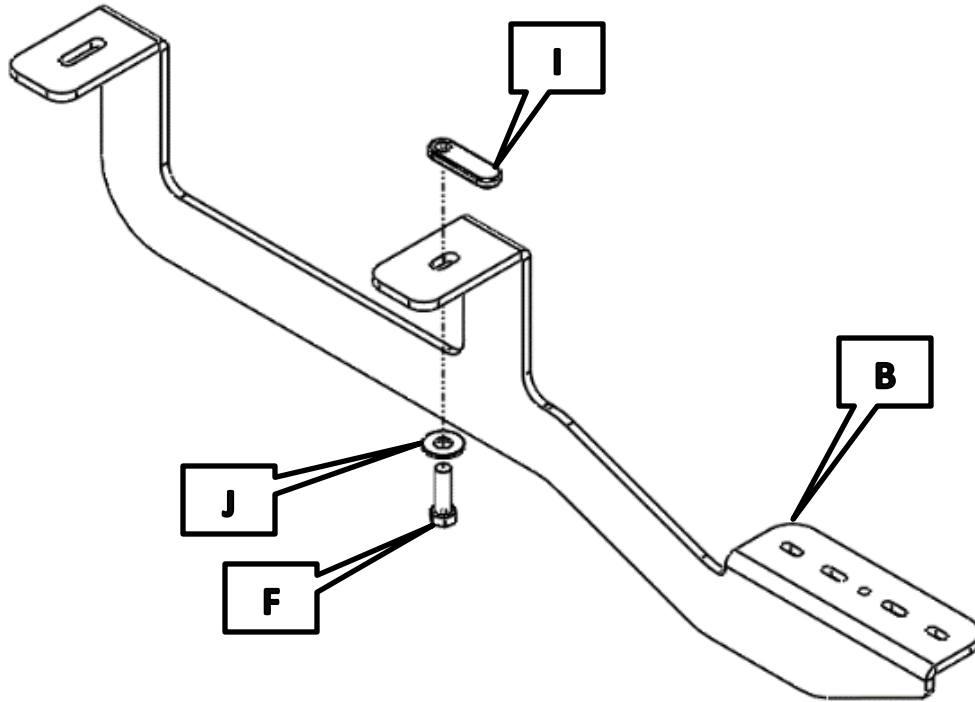

- 4** Insert the M10 thread plate while still attached to the bracket into the rear mounting location of the vehicle. Then align the bracket with the front mounting location.



5 Insert bolt (F) and washer (J) into front mounting location. Do not fully tighten at this time.

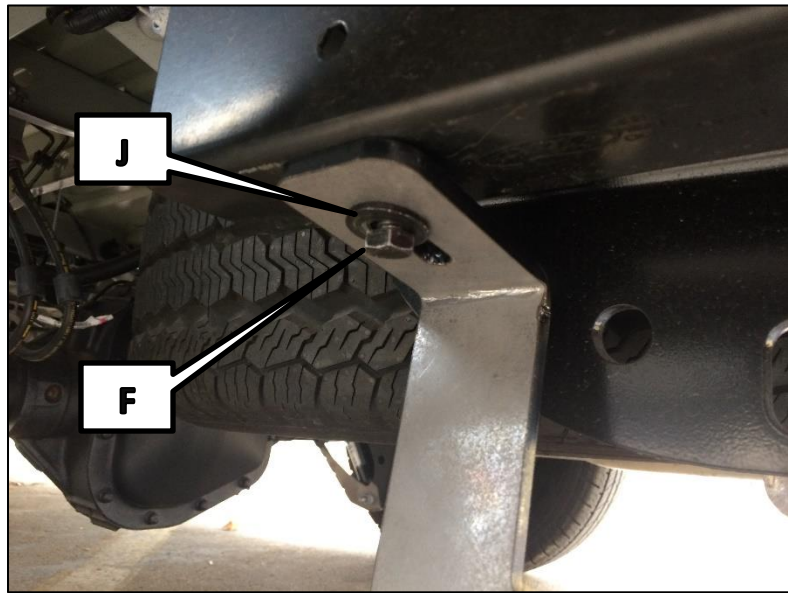

6 Repeat steps 1-5 on the right side using the right bracket (C). If your van has a rear tow hook, it will need to be removed.



7

Place the running board (A) onto the brackets and center the board. Insert a Strap Bracket (D) into the body of the running board on top of each bracket.



8

Insert bolts (K) and washers (G) through each strap bracket and both braces. Then install washer (G) and nut (H) on the bottom of the brackets. Fully tighten the board to the braces then tighten the braces to the vehicle.

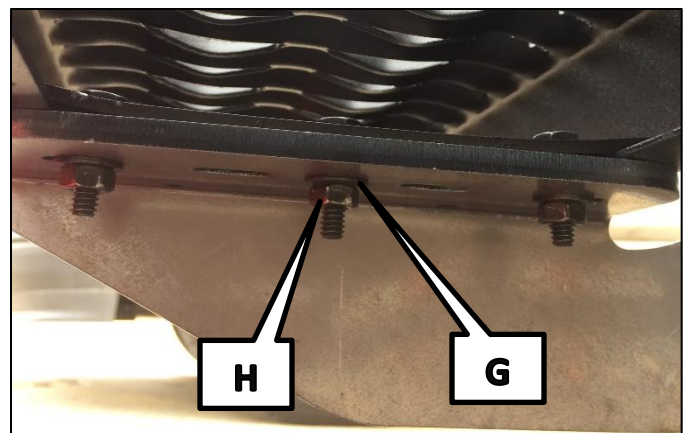
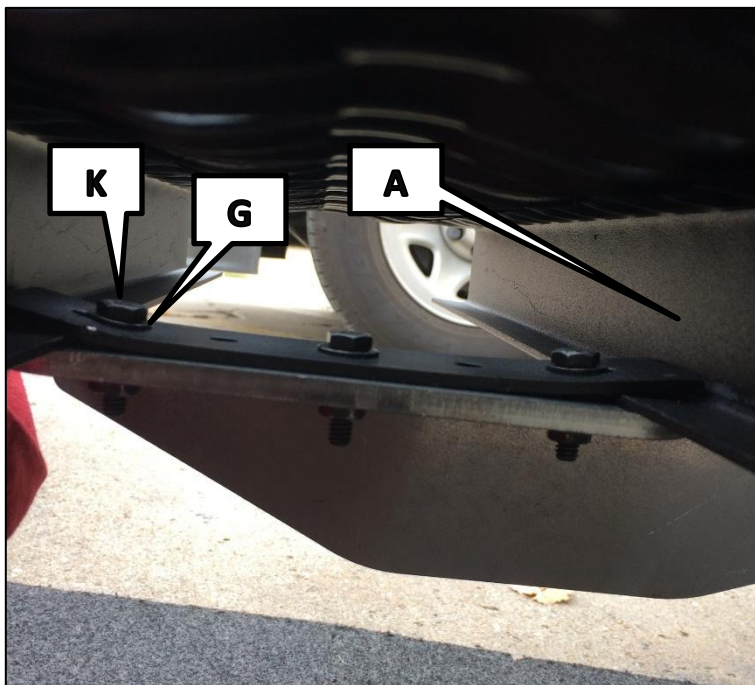

- 9** Slide the pre-assembled end cap into the end of the board (A) until the end cap is flush with the end of the board. The end cap must be inside the board and the strap bracket outside the board. Tighten the bolts with a 7/16" wrench and socket.

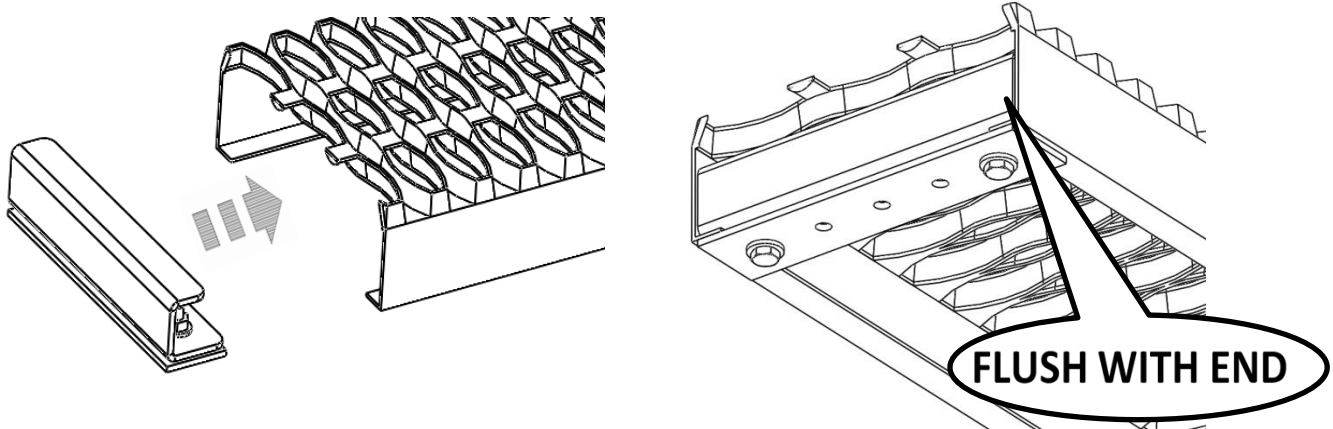

If you do not have the end caps already assembled, refer to the instructions included with the running board.